

Bottom

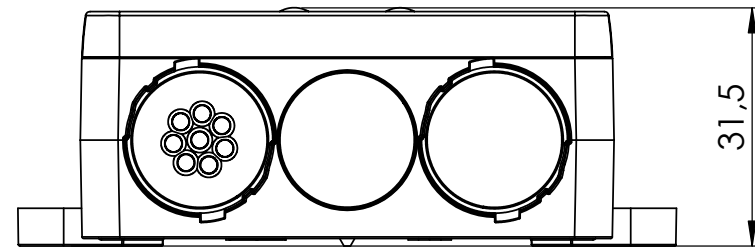

Front

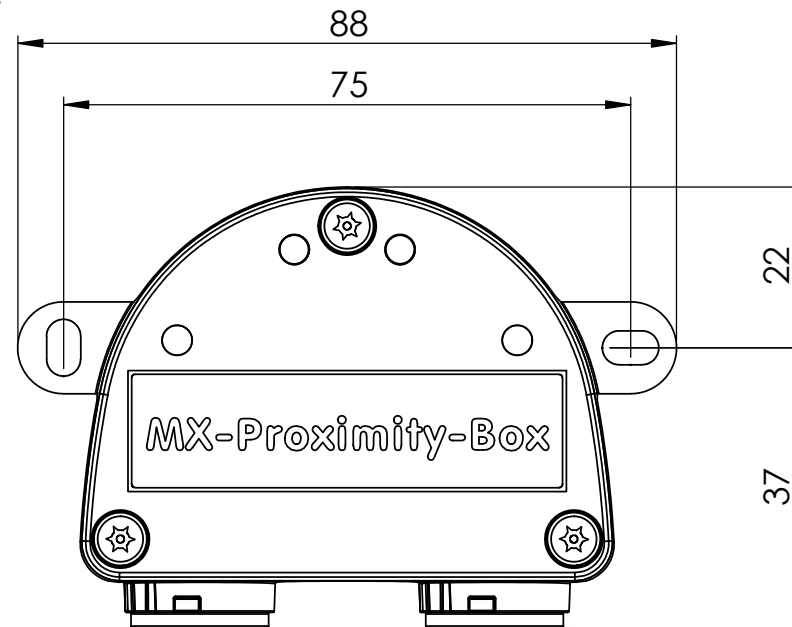

Side

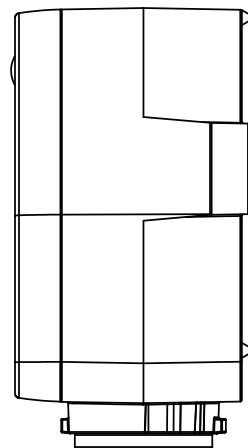

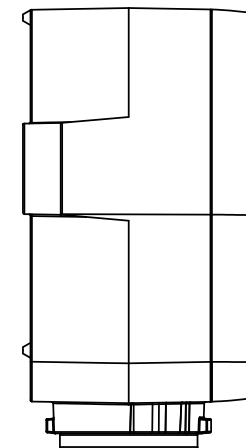

Side

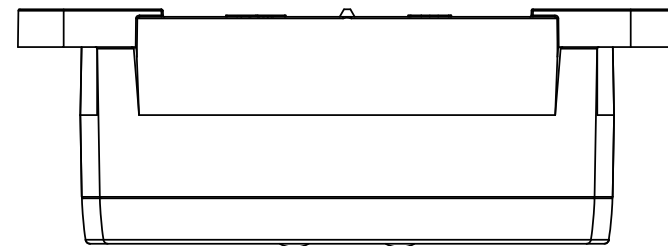

Top

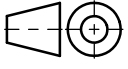

For internal use only. Technical specifications subject to change without notice. MOBOTIX does not assume responsibility for mistakes and recommends to verify measures and mechanical design with an actual product of the chosen MOBOTIX hardware. The reproduction, distribution and utilization of this document as well as the communication of its contents to others without express authorization is prohibited. Offenders will be held liable for the payment of damages. All rights reserved in the event of the grant of a patent, Utility model, design or trademark. No rights are transferred herewith.

Für diese Unterlage behalten wir uns alle Rechte vor. Sie darf nur für den von uns bestimmten Zweck benutzt und ohne unsere Zustimmung weder vervielfältigt noch Dritten zugänglich gemacht werden.		Datum Name Bearb. 01.06.2018 PWe	Werkstoff	Gewicht
		Geprüft Norm CAD-A3 SolidWorks	Zul. Abweichung für Maße ohne Toleranzangaben: ISO 2768 -I -H Artikel REACH- und RoHS - konform (Richtlinie 2011/65/EU)	
		MX-Proximity-Box_Doku		
Bez. Änderung Datum Name	Ersatz für		Blatt 1 von 1	